

Cost-effective Medium Performance Power Inlet Filter

EEJ Series

Including the EJH/EJHS, EJM/EJMS and EJS Models



**UL Recognized
CSA Certified
VDE Approved***

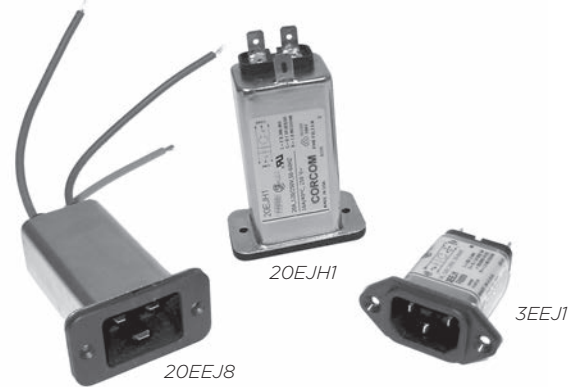

EEJ Series

- Compact EMI filter with IEC 60320-1 C14 Inlet
- Enhanced two element circuit provides medium attenuation to 30MHz
- Compact and cost-effective design
- Supersedes most ED Series versions
- Includes 20A version with standard IEC 60320-1 C20 inlet
- Several termination styles
- Flanged mounting

EJS Models

- Same performance as the EEJ Series
- Snap-in mounting
- Several termination styles
- Includes 20A version with standard IEC 60320-1 C20 inlet

EJH & EJHS Models

- Minimal leakage current suitable for patient-contact medical applications
- Flanged mounting the same as the EEJ Series
- Also available in snap-in versions (EJHS)
- Two element circuit provides modest EMI attenuation above 1MHz
- Capacitive input (refer to the H Series for capacitive output)
- EJHS models feature snap-in mounting

EJM & EJMS Models

- Low leakage current, suitable for most medical applications
- Improved EMI attenuation up to 200MHz
- Mechanically the same as the EEJ Series with flange or snap-in mounting
- EJMS models feature snap-in mounting

Specifications

Maximum leakage current each Line to Ground:

	<u>EEJ/EJS</u>	<u>EJH</u>	<u>EJM</u>
@ 120 VAC 60 Hz:	.22 mA	2 µA	.01 mA
@250 VAC 50 Hz:	.38 mA	5 µA	.017 mA

Hipot rating (one minute):

Line to Ground:	2250 VDC
Line to Line:	1450 VDC

Rated Voltage (max.):

250 VAC

Operating Frequency:

50/60 Hz

Rated Current:

1 to 20A*

Operating Ambient Temperature Range

(at rated current I_r): -10°C to +40°C
In an ambient temperature (T_a) higher than +40°C the maximum operating current (I_o) is calculated as follows: $I_o = I_r \sqrt{(85-T_a)/45}$

Electrical Schematic



Note 1: Not present in EJH versions

**15A versions are tested by Underwriters Laboratories to US and Canadian requirements and are VDE approved at 10A, 250VAC*

20A versions are tested by Underwriters Laboratories to US and Canadian requirements and are VDE approved at 16A, 250VAC

Cost-effective Medium Performance Power Inlet Filter *(continued)*

EEJ Series

Including the EJH/EJHS, EJM/EJMS and EJS Models

Ordering Information

3 EEJ 1

Output Styles

- 1 - .250 [6.3] spade terminals
(back)
- 2 - .250 [6.3] spade terminals
(bottom)
- P - PC board pins
- 8 - Wire leads

Series

- EEJ - Enhanced EMI Inlet Filter
- EJS - EEJ in Snap-in Mounting
- EJH - Enhanced Medical Inlet Filter
- EJHS - EJH in Snap-in Mounting
- EJM - Extended Performance Medical Inlet Filter
- EJMS - EJM in Snap-in Mounting

Current Rating

- 1, 3, 6, 10, 15 or 20A

Accessories

GA400: NEMA 5-15P to IEC 60320-1 C-13 line cord



FA601: Insulating Shroud

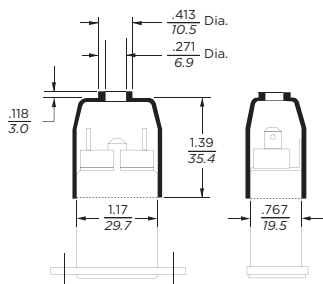

Available Part Numbers

EEJ Models	EJH Models
1EEJ1	1EJH1
1EEJ2	1EJH2
1EEJP	1EJHP
1EEJ8	1EJH8
3EEJ1	3EJH1
3EEJ2	3EJH2
3EEJP	3EJHP
3EEJ8	3EJH8
6EEJ1	6EJH1
6EEJ2	6EJH2
6EEJP	6EJHP
6EEJ8	6EJH8
10EEJ1	10EJH1
10EEJ2	10EJH2
10EEJP	10EJHP
10EEJ8	10EJH8
15EEJ1	15EJH1
15EEJ2	15EJH2
15EEJP	15EJHP
15EEJ8	15EJH8
20EEJ1	20EJH1
20EEJ8	20EJH8
EJS Models	EJHS Models
1EJS1	1EJHS1
1EJS8	1EJHS8
3EJS1	3EJHS1
3EJS8	3EJHS8
6EJS1	6EJHS1
6EJS8	6EJHS8
10EJS1	10EJHS1
10EJS8	10EJHS8
15EJS1	15EJHS1
15EJS8	15EJHS8
20EJS1	
20EJS8	
EJM Models	EJMS Models
1EJM1	1EJMS1
1EJM8	1EJMS8
3EJM1	3EJMS1
3EJM8	3EJMS8
6EJM1	6EJMS1
6EJM8	6EJMS8
10EJM1	10EJMS1
10EJM8	10EJMS8
15EJM1	15EJMS1
15EJM8	15EJMS8

Cost-effective Medium Performance Power Inlet Filter *(continued)*

EEJ Series

 Including the EJH/EJHS, EJM/EJMS and EJS Models

Case Styles

EEJ1, EJH1 & EJM1 *(1-15A)*



Typical Dimensions:
 Mounting holes (2): .132 [3.35] Dia. with .236 [5.99] Dia. x 90° countersink for #4 flathead screw
 Line Inlet (1): IEC 60320-1 C14
 Load Terminals (2): .250 [6.3] with .07 [1.8] Dia. hole
 Ground Terminal (1): .250 [6.3] with .07 x .16 [1.8 x 3.8] slot

EEJ2 & EJH2 *(1-15A)*

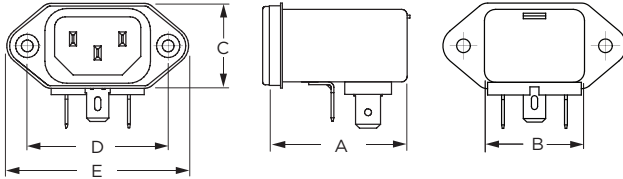

Typical Dimensions:
 Mounting holes (2): .132 [3.35] Dia. with .236 [5.99] Dia. x 90° countersink for #4 flathead screw
 Line Inlet (1): IEC 60320-1 C14
 Load Terminals (2): .250 [6.3] with .07 [1.8] Dia. hole
 Ground Terminal (1): .250 [6.3] with .07 x .16 [1.8 x 3.8] slot

EEJP & EJHP *(1-15A)*

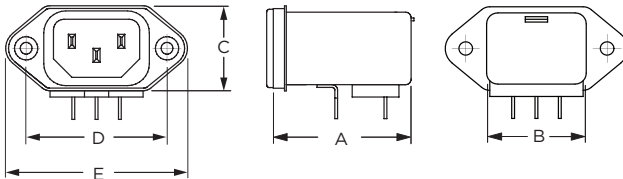

Typical Dimensions:
 Mounting holes (2): .132 [3.35] Dia. with .236 [5.99] Dia. x 90° countersink for #4 flathead screw
 Line Inlet (1): IEC 60320-1 C14
 PC board pins (3): .031 [.07] square, ± .003 [.07]

EJS1, EJHS1 & EJMS1 *(1-15A)*



Typical Dimensions:
 Line Inlet (1): IEC 60320-1 C14
 Load Terminals (2): .250 [6.3] with .07 [1.8] Dia. hole
 Ground Terminal (1): .250 [6.3] with .07 x .16 [1.8 x 3.8] slot

EEJ8, EJH8 & EJM8 *(1-15A)*

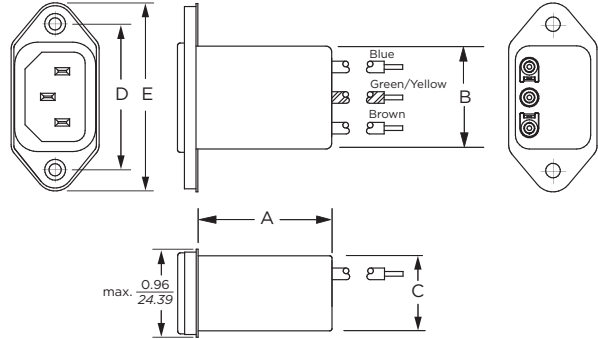

Typical Dimensions:
 Mounting holes (2): .132 [3.35] Dia. with .236 [5.99] Dia. x 90° countersink for #4 flathead screw
 Line Inlet (1): IEC 60320-1 C14
 Wire Leads: 4.0 [101.6] Min., 18AWG, UL1015

EJS8, EJHS8 & EJMS8 *(1-15A)*



Typical Dimensions:
 Line Inlet (1): IEC 60320-1 C14
 Wire Leads: 4.0 [101.6] Min., 18AWG, UL1015

20EEJ1 & 20EJH1



Typical Dimensions:
 Mounting holes (2): .132 [3.35] Dia. with .236 [5.99] Dia. x 90° countersink for #4 flathead screw
 Line Inlet (1): IEC 60320-1 C20
 Load Terminals (2): .250 [6.3] with .07 [1.8] Dia. hole
 Ground Terminal (1): .250 [6.3] with .07 x .16 [1.8 x 3.8] slot

Cost-effective Medium Performance Power Inlet Filter *(continued)*

EEJ Series

Including the EJH/EJHS, EJM/EJMS and EJS Models

Case Styles *(continued)*

20EJS1



Typical Dimensions:

Line Inlet (1):	IEC 60320-1 C20
Load Terminals (2):	.250 [6.3] with .07 [1.8] Dia. hole
Ground Terminal (1):	.250 [6.3] with .07 x .16 [1.8 x 3.8] slot

20EEJ8 & 20EJH8



Typical Dimensions:

Mounting holes (2):	.132 [3.35] Dia. with .236 [5.99] Dia. x 90° countersink for #4 flathead screw
Line Inlet (1):	IEC 60320-1 C20
Wire Leads:	4.0 [101.6] Min., 14AWG, UL1015

20EJS8



Typical Dimensions:

Line Inlet (1):	IEC 60320-1 C20
Wire Leads:	4.0 [101.6] Min., 14AWG, UL1015

Recommended Panel Cutouts

1 to 15A EEJ, EJH & EJM



Tolerances ± .005 [0.13] unless otherwise noted

- Note 1: EEJ/EJH/EJM1 and EEJ/EJH/EJM8 can be front or back mounted
 Note 2: EEJ/EJH2 and EEJ/EJHP can be back mounted only

20A EEJ & EJH



Tolerances ± .005 [0.13] unless otherwise noted

- Note 1: 20EEJ/EJH1 and 20EEJ/EJH8 can be front or back mounted

1 to 15A EJHS, EJMS & EJS



Alternate snap configurations to fit other cut-out sizes also available.
 Contact TE's Corcom product engineering group for more details.

20A EJS

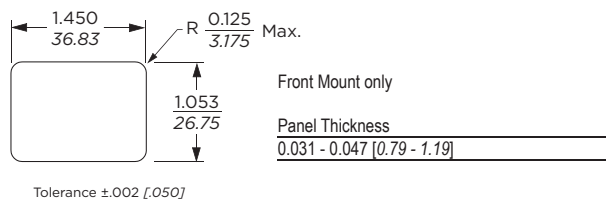

PC Board Layout



Cost-effective Medium Performance Power Inlet Filter *(continued)*

EEJ Series

Including the EJH/EJHS, EJM/EJMS and EJS Models

Case Dimensions

Part No.	A (max.)	B (max.)	C (max.)	D ± 0.15 $\pm .38$	E (max.)	F (ref.)
EEJ1, EJH1	2.15 <i>54.61</i>	1.13 <i>28.70</i>	0.96 <i>24.38</i>	1.580 <i>40.00</i>	2.04 <i>51.76</i>	-
EJM1	2.02 <i>51.3</i>	1.13 <i>28.7</i>	0.96 <i>24.4</i>	1.58 <i>40.00</i>	2.04 <i>51.8</i>	-
1-10A	1.54	1.13	0.96	1.580	2.04	-
EEJ2, EJH2	39.12	28.70	24.38	40.00	51.76	-
15A	1.79	1.13	0.96	1.580	2.04	-
EEJ2, EJH2	45.47	28.70	24.38	40.00	51.76	-
1-10A	1.54	1.13	0.96	1.580	2.04	-
EEJP, EJHP	39.12	28.70	24.38	40.00	51.76	-
15A	1.79	1.13	0.96	1.580	2.04	-
EEJP, EJHP	45.47	28.70	24.38	40.00	51.76	-
EJS1, EJHS1	2.20 <i>55.88</i>	1.13 <i>28.70</i>	0.96 <i>24.38</i>	1.19 <i>30.10</i>	1.41 <i>35.81</i>	-
EJMS1	2.02 <i>51.3</i>	1.13 <i>28.7</i>	0.96 <i>24.4</i>	-	1.41 <i>35.8</i>	-
EEJ8, EJH8	1.54 <i>39.12</i>	1.13 <i>28.70</i>	0.81 <i>20.70</i>	1.58 <i>40.00</i>	2.04 <i>51.76</i>	-
EJM8	1.50 <i>38.1</i>	1.13 <i>28.7</i>	0.81 <i>20.7</i>	1.58 <i>40.00</i>	2.04 <i>51.8</i>	-
EJS8, EJHS8	1.54 <i>39.12</i>	1.13 <i>28.70</i>	0.81 <i>20.70</i>	1.19 <i>30.10</i>	1.41 <i>35.81</i>	-
EJMS8	1.50 <i>38.1</i>	1.13 <i>28.7</i>	0.96 <i>24.4</i>	-	1.41 <i>35.8</i>	-
20EEJ1, 20EJH1	3.13 <i>79.38</i>	1.37 <i>34.79</i>	1.18 <i>29.99</i>	1.65 <i>42.01</i>	2.09 <i>53.00</i>	-
20EJS1	3.13 <i>79.38</i>	1.35 <i>34.29</i>	1.18 <i>29.99</i>	1.42 <i>36.07</i>	1.46 <i>37.08</i>	-
20EEJ8, 20EJH8	2.65 <i>67.31</i>	1.35 <i>34.29</i>	1.18 <i>29.99</i>	1.65 <i>42.01</i>	2.09 <i>53.00</i>	.62 <i>15.75</i>
20EJS8	2.63 <i>66.80</i>	1.35 <i>34.29</i>	1.18 <i>29.97</i>	1.46 <i>37.08</i>	1.42 <i>36.08</i>	.62 <i>15.75</i>



Performance Data

Typical Insertion Loss

Measured in closed 50 Ohm system

EEJ & EJS Models

1A



3A



6A



10A



15A



20A



— Common Mode / Asymmetrical (L-G)
- - - Differential Mode / Symmetrical (L-L)

Cost-effective Medium Performance Power Inlet Filter *(continued)*

EEJ Series

Including the EJH/EJHS, EJM/EJMS and EJS Models

Performance Data

(continued)

Typical Insertion Loss

Measured in closed 50 Ohm system

EJH & EJHS Models

1A



3A



6A



10A



15A



20A



EJM & EJMS Models

1A



3A



6A



10A



15A

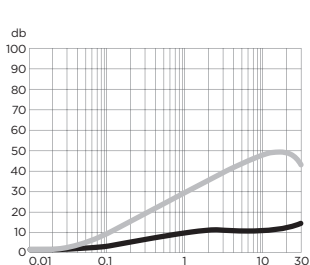

— Common Mode / Asymmetrical (L-G)
— Differential Mode / Symmetrical (L-L)

Cost-effective Medium Performance Power Inlet Filter *(continued)*

EEJ Series

Including the EJH/EJHS, EJM/EJMS and EJS Models

Minimum Insertion Loss

Measured in closed 50 Ohm system

Common Mode / Asymmetrical (Line to Ground)

Current Rating	Frequency – MHz								
	.01	.05	.1	.15	.5	1	5	10	30
EEJ / EJS Models									
1A	15	27	29	32	41	47	47	47	40
3A	-	10	15	20	30	39	48	50	60
6A	-	1	5	9	21	28	41	44	54
10A	-	1	4	7	14	18	31	36	51
15A	-	-	-	2	5	8	21	26	42
20A	-	-	3	5	14	21	30	33	42
EJH Models									
1A	13	26	33	36	41	41	31	26	18
3A	-	9	15	19	27	31	30	26	20
6A	-	2	6	9	20	22	31	20	18
10A	-	1	4	7	12	17	19	18	18
15A	-	-	1	2	3	3	4	2	2
20A	-	-	3	5	14	16	12	11	11

Differential Mode / Symmetrical (Line to Line)

Current Rating	Frequency – MHz										
	.01	.05	.1	.15	.5	1	5	10	30	EEJ	EJS
EEJ / EJS Models											
1A	-	-	5	8	19	27	45	43	40	9	
3A	-	-	5	8	17	20	39	42	40	11	
6A	-	-	5	8	17	21	32	40	40	16	
10A	-	-	5	8	17	21	23	36	38	16	
15A	-	-	5	8	17	23	33	30	38	11	
20A	-	-	5	2	17	25	38	48	48	48	
EJH Models											
1A	13	26	33	36	41	41	31	26	18		
3A	-	9	15	19	27	31	30	26	20		
6A	-	2	6	9	20	22	31	20	18		
10A	-	1	4	7	12	17	19	18	18		
15A	-	-	1	2	3	3	4	2	2		
20A	-	-	3	5	14	16	12	11	11		

EJM & EJMS Models

Current Rating	Frequency – MHz								
	.05	.5	1	10	20	30	80	150	200
1A	25	41	37	18	15	13	15	14	7
3A	6	27	30	21	19	19	23	13	7
6A	2	17	20	17	17	14	23	13	7
10A	1.5	11	12	9	8	9	20	19	12
15A	0.5	2	3	4	2	10	12	17	11

Current Rating	Frequency – MHz								
	.05	.5	1	10	20	30	80	150	200
1A	1.5	21	28	34	36	29	27	34	28
3A	1.5	17	23	29	31	37	33	32	28
6A	1.5	16	22	28	29	34	37	37	32
10A	2	16	22	28	24	18	27	32	30
15A	1.5	17	23	35	34	29	27	29	25

